

4

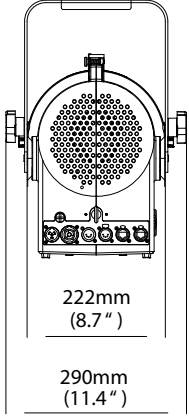

3

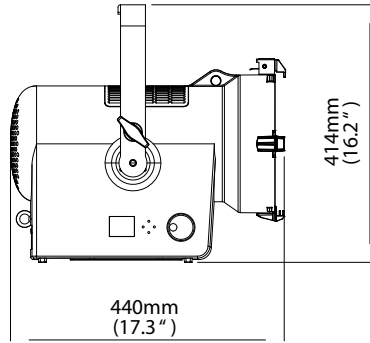

2

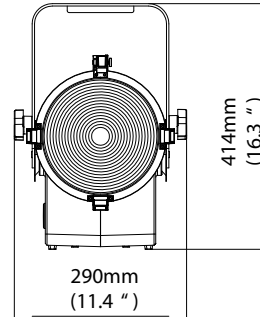

1

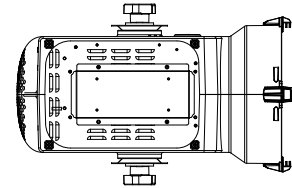

290mm
(11.4")

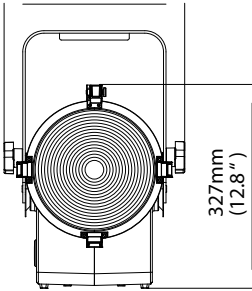

197mm
(7.7")

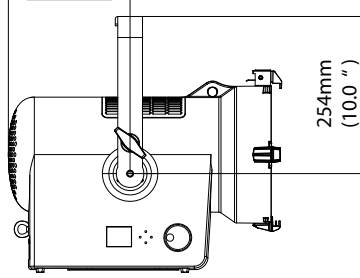

Ø222mm
(8.7")

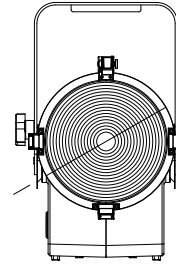

290mm
(11.4")

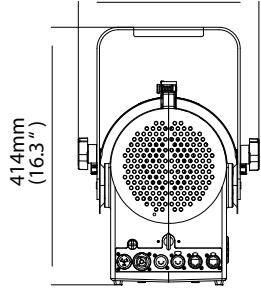

NOTES:
1. DIMENSION UNITS ARE MM/[IN].

		ACCLAIM FRESNEL+ OVERALL DIMENSION DRAWING			
DATE	SIZE	REVISION	DRAWING NUMBER		
1/23	D	A	64511-007		
© 2024 SIGNIFY HOLDING. ALL RIGHTS RESERVED		SCALE	0.33	CREO 3.0	SHEET 11 OF 11