

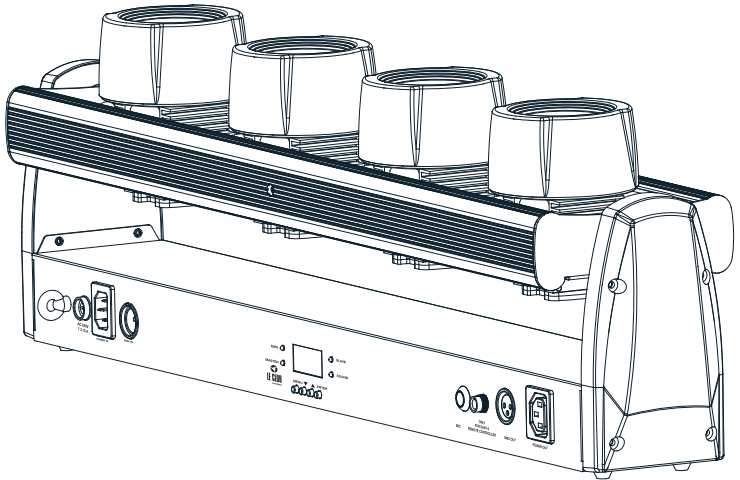

**LE CLUB**  
*Contest*

**4X10W WHITE LEDS  
4-PROJECTOR BAR  
WITH PAN AND TILT  
MOVEMENTS**



**FireStorm-4x10WH**

**USER GUIDE**  
10291 - 1 January 2015

# 1 - Safety information

## Important safety information



This unit is intended for indoor use only. Do not use it in a wet, or extremely cold/hot locations. Failure to follow these safety instructions could result in fire, electric shock, injury, or damage to this product or other property.



Any maintenance procedure must be performed by a CONTEST authorised technical service. Basic cleaning operations must thoroughly follow our safety instructions.



This product contains non-isolated electrical components. Do not undertake any maintenance operation when it is switched on as it may result in electric shock.

## Symbols used



This symbol signals an important safety precaution.



The WARNING symbol signals a risk to the user's physical integrity. The product may also be damaged.



The CAUTION symbol signals a risk of product deterioration.

## Instructions and recommendations

### 1 - Please read carefully :

We strongly recommend to read carefully and understand the safety instructions before attempting to operate this unit.

### 2 - Please keep this manual :

We strongly recommend to keep this manual with the unit for future reference.

### 3 - Operate carefully this product :

We strongly recommend to take into consideration every safety instruction.

### 4 - Follow the instructions:

Please carefully follow each safety instruction to avoid any physical harm or property damage.

### 5 - Avoid water and wet locations :

Do not use this product in rain, or near washbasins or other wet locations.

### 6 - Installation :

We strongly encourage you to only use a fixation system or support recommended by the manufacturer or supplied with this product. Carefully follow the installation instructions and use the adequate tools. Always ensure this unit is firmly fixed to avoid vibration and slipping while operating as it may result in physical injury.

### 7 - Ceiling or wall installation :

Please contact your local dealer before attempting any ceiling or wall installation.

### 8 - Ventilation :

The cooling vents ensure a safe use of this product, and avoid any overheating risk. Do not obstruct or cover these vents as it may result in overheating and potential physical injury or product damage. This product should never be operated in a closed non-ventilated area such as a flight case or a rack, unless cooling vents are provided for the purpose .

### 9 - Heat exposure :

Sustained contact or proximity with warm surfaces may cause overheating and product damages. Please keep this product away from any heat source such as a heaters, amplifiers, hot plates, etc..

### 10 - Electric power supply :

This product can only be operated according to a very specific voltage. These information are specified on the label located at the rear of the product.

### 11 - Power cords protection:

Power-supply cords should be routed so that they are not likely to be walked on or pinched by items placed upon or against them, paying particular attention to cords at lugs, convenience receptacles and the point where they exit from the fixture.

**WARNING :** This unit contains no user-serviceable parts. Do not open the housing or attempt any maintenance by yourself. In the unlikely even your unit may require service, please contact your nearest dealer.



**CAUTION**  
RISK OF ELECTRIC SHOCK  
DO NOT OPEN



In order to avoid any electrical malfunction, please do not use any multi-socket, power cord extension or connecting system without making sure they are perfectly isolated and present no defect.



### Warning

This product is equipped with Class 2 LEDs. Please avoid looking directly at the beam as it may cause severe eye injuries.

## Recycling your device



- As HITMUSIC is really involved in the environmental cause, we only commercialise clean, ROHS compliant products.
- When this product reaches its end of life, take it to a collection point designated by local authorities. The separate collection and recycling of your product at the time of disposal will help conserve natural resources and ensure that it is recycled in a manner that protects human health and the environment.

### 12 - Cleaning precautions :

Unplug the product before attempting any cleaning operation. This product should be cleaned only with accessories recommended by the manufacturer. Use a damp cloth to clean the surface. Do not wash this product.

### 13 - Long periods of non use :

Disconnect the unit's main power during long periods of non use.

### 14 - Liquids or objects penetration :

Do not let any object penetrate this product as it may result in electric shock or fire. Never spill any liquid on this product as it may infiltrate the electronic components and result in electric shock or fire.

### 15 - This product should be serviced when :

Please contact the qualified service personnel if :

- The power cord or the plug has been damaged.
- Objects have fallen or liquid has been spilled into the appliance.
- The appliance has been exposed to rain or water.
- The product does not appear to operate normally.
- The product has been damaged.

### 16 - Inspection/maintenance :

Please do not attempt any inspection or maintenance by yourself. Refer all servicing to qualified personnel.

### 17 - Operating environment :

Ambient temperature and humidity: +5 - +35°C, relative humidity must be less than 85% (when cooling vents are not obstructed).

Do not operate this product in a non-ventilated, very humid or warm place.

## 2 - Technical specifications

### Light sources

- › 4x10W Dazzling white LEDs projectors - 50 000 hours (expected)
- › 7° aperture angle (individual lenses)
- › Low temperature, low power consumption, can be operated non-stop for many hours

### Effects

- › Adjustable strobe
- › Adjustable flash effect
- › Adjustable electronic dimmer from 0 - 100%

### Control

- › Standard DMX-512
- › 1 / 11A / 11B / 15 DMX channels
- › Simplified settings (Compatible EASY-2)
- › Built-in music-sensitive program via the internal microphone
- › Simplified control of several projectors simultaneously
- › LCD drop-down menu to choose and assign the different modes

### Movements

- › TILT bar movement
- › Each projector independently rotates on a 90° PAN angle

### Package contents :

The package must include the following articles:

- › The projector
- › The user guide
- › 1x2-pole + earth IEC power cord
- › Two retaining brackets with Quicklock fasteners

### Additional characteristics

- › Holding brackets with Omega holders
- › Power consumption : 80W max.
- › Power supply : 100/230V - 50/60Hz, AC
- › Dimensions : 791 x 152 x 232 mm
- › Net weight: 10.2 Kg

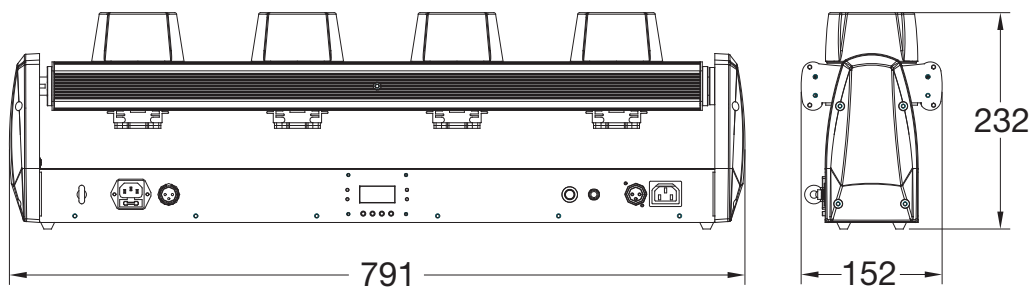

### 3 - Rear panel description

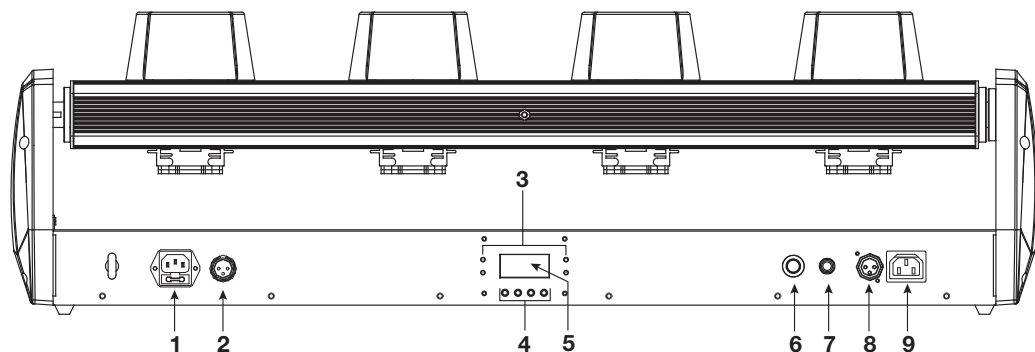

#### 1 Entrée alimentation

Permet de relier le projecteur au secteur.  
Veillez à ce que le voltage corresponde aux instructions notées sur le produit.

#### 2 Entrée DMX

Fiches XLR 3 broches femelle câblée comme suit :

- Masse en 1
- Signal négatif en 2
- Signal positif en 3

#### 3 Indicator LEDs

These 4 LEDs indicate the device status.

LED	Indication
DMX	is ON when the DMX mode is activated
MASTER	is ON when the Master mode is activated
SLAVE	is ON when the Slave mode is activated
SOUND	Flashes when the Sound-sensitive mode is activated

#### 4 Menu settings

##### MENU

Press MENU to access and select the functions.

##### ENTER

Press ENTER to access a sub-menu and or save changes selected via the UP and DOWN buttons.

##### UP and DOWN

Press UP or DOWN to increase/decrease the adjustable values or browse the sub-menus.

#### 5 Display

This intuitive display allows you to configure your projector. Please refer to the next paragraphs for more details about the projector configuration. The display backlight can be deactivated via the Back Light command menu.

#### 6 Microphone

The microphone is used for the music-sensitive modes.

#### 7 Stereo Jack 6.35 input

This input allows you to plug in the EASY-2 optional remote control.

Only the EASY-2 remote control should use this input, as plugging other devices may result in severe damages to the internal electrics.

#### 8 DMX output



3-pin male XLR plug hardwired as follows :











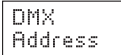

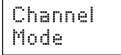



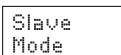



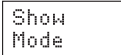

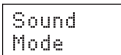

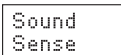

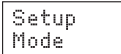
- Mass: 1
- Negative signal: 2
- Positive signal: 3

#### 9 Power output socket

Allows you to link two projectors together via a Male/Female IEC cord. You can daisy up to 8 projectors.

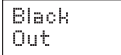
## 4 - Internal menu

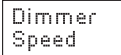
Once turned on, the moving head will start a position initialisation for each motor. At this stage, the display indicates . Once the initialisation is over, the display will indicate  you will then be able to access the menu using the MENU or ENTER buttons. If the menu remains inactive for 30 seconds, the display will indicate  and locks. To access the menu again, press ENTER.

MENU	UP and DOWN	Action	ENTER
		DMX address selection Press ENTER and select the address with UP and DOWN	Saves changes
		<b>1 channel</b> : Select the pre-programmed sequences: 0 - 8	Saves changes
		<b>11 A channels</b> : Pan1, Pan2, Pan3, Pan4, Tilt, Movement macros, Movement macros speed, Main dimmer, Strobe, Effect macros, Effect macros speed	
		<b>11 B channels</b> : Pan1, Pan2, Pan3, Pan4, Tilt, Main dimmer, Strobe, Individual LED dimmers	
		<b>15 channels</b> : Non-stop Pan, Pan, Tilt1, Tilt2, Tilt3, Movement macros, Movement macros speed, Main dimmer, Strobe, Effect macros, Effect macros speed, Individual LED dimmers	
		<b>Master</b> , Slave1 and Slave 2 modes selection. Press ENTER and use the UP and DOWN buttons to select a mode. The Slave 2 mode reverses the PAN and TILT movements, and the sequences order in relation to the master projector.	Saves changes
			
			
		Shows are music-sensitive. Please make sure the music-sensitive mode is activated (menu Sound State).  Show 0 starts a 1 - 8 show sequencing.	Saves changes
			
		Activates or deactivates the music-sensitive mode. Press ENTER and select On or Off with the UP and DOWN buttons.	Saves changes
			
		Adjusts the microphone sensitivity (for music-sensitive modes) . When the value is 000, the microphone is deactivated.	Saves changes
		Configures the maximum amplitude of TILT movements. The 120 F value forces a one-sided beam projection.	Saves changes
			
			
			
			
		Activates or deactivates the Black out mode. Press ENTER and select On or Off with the UP and DOWN buttons.	Saves changes
			
		Allows you to configure the dimmer speed.	Saves changes
			

MENU	UP and DOWN	Action	ENTER
Back Light	On Off	Activates or deactivates the display backlight. Press ENTER and select On or Off with the UP and DOWN buttons. When Off, the display automatically turns off after a 30-second inactivity period.	Saves changes
Tilt Inverse	Normal Inverse	Activates the TILT movement reversion when the Slave mode is activated, or in DMX mode. Press ENTER and select Yes or No with UP and DOWN.	Saves changes
Pan 1 Inverse	Normal Inverse	Activates the projector 1 PAN movement reversion when the Slave and Show modes are activated, or in DMX mode. Press ENTER and select Yes or No with UP and DOWN.	Saves changes
Pan 2 Inverse	Normal Inverse	Activates the projector 2 PAN movement reversion when the Slave and Show modes are activated, or in DMX mode. Press ENTER and select Yes or No with UP and DOWN.	Saves changes
Pan 3 Inverse	Normal Inverse	Activates the projector 3 PAN movement reversion when the Slave and Show modes are activated, or in DMX mode. Press ENTER and select Yes or No with UP and DOWN.	Saves changes
Pan 4 Inverse	Normal Inverse	Activates the projector 4 PAN movement reversion when the Slave and Show modes are activated, or in DMX mode. Press ENTER and select Yes or No with UP and DOWN.	Saves changes
Lamp Inverse	Normal Inverse	Reverses the movement sequences. When No is selected, the sequences are executed from right to left, when Yes is selected, they are executed from left to right. Press ENTER and select Yes or No with UP and DOWN.	Saves changes
Auto Test	Test...	Tests each function.	Launches the test
Fixture Hours	xxx	Displays the total operating hours since the product was switched on for the first time.	No action
Software Version	A :UX.X Ab:UX.X	Displays the current software versions.	No action
Reset		Resets the device	Resets

## 4.2 - Initial position settings

After initialising, the moving head is automatically positioned on its original positions.

You can configure this positions as it pleases you.

Enter the DMX Address menu, then press ENTER for more than 3 seconds. You are now accessing the initial position settings.

Tilt Offset	000-255	TILT movement initial position settings.
Pan 1 Offset	000-255	PAN 1 movement initial position settings.
Pan 2 Offset	000-255	PAN 2 movement initial position settings.
Pan 3 Offset	000-255	PAN 3 movement initial position settings.
Pan 4 Offset	000-255	PAN 4 movement initial position settings.

## 5 - The various DMX modes

Press the MENU button for more than 3 seconds to activate the DMX mode.

### 5.1 - 1-channel mode

Channels	Values	Action
1	000 - 007	Black-out
	008 - 015	Show 0 automatic
	016 - 041	Show 1 music-sensitive
	042 - 067	Show 2 music-sensitive
	068 - 093	Show 3 music-sensitive
	094 - 119	Show 4 music-sensitive
	120 - 145	Show 5 music-sensitive
	146 - 171	Show 6 music-sensitive
	172 - 197	Show 7 music-sensitive
	198 - 223	Show 8 music-sensitive
	224 - 255	Show 0 music-sensitive

## 5.2 - 11 channels A mode

Channels	Values	Action
1	<b>PAN 1 movement</b>	
	000 - 255	Projector 1 PAN movement: -45° - 45°
2	<b>PAN 2 movement</b>	
	000 - 255	Projector 2 PAN movement: -45° - 45°
3	<b>PAN 3 movement</b>	
	000 - 255	Projector 3 PAN movement: -45° - 45°
4	<b>PAN 4 movement</b>	
	000 - 255	Projector 4 PAN movement: -45° - 45°
5	<b>TILT movement</b>	
	000 - 255	TILT movement
6	<b>Movement macros</b>	
	000 - 007	No action
	008 - 034	Macro 1 : Show 1 without light effects
	035 - 061	Macro 2 : Show 2 without light effects
	062 - 088	Macro 3 : Show 3 without light effects
	089 - 115	Macro 4 : Show 4 without light effects
	116 - 142	Macro 5 : Show 5 without light effects
	143 - 169	Macro 6 : Show 6 without light effects
	170 - 196	Macro 7 : Show 7 without light effects
	197 - 223	Macro 8 : Show 8 without light effects
224 - 255	Macro 9 : Show 0 without light effects	
7	<b>Movement macros speed</b>	
	000 - 007	No action
	008 - 247	Increasing speed
248 - 255	Music-sensitive mode	
8	<b>Main dimmer</b>	
	000 - 007	Black-Out
	008 - 255	Dimmer: 0 - 100%
9	<b>Strobe</b>	
	000 - 015	Black-out
	016 - 131	Stroboscope at increasing speed
	132 - 139	Open
	140 - 181	Pulse effect
	182 - 189	Open
	190 - 231	Reversed Pulse effect
	232 - 239	Open
	240 - 247	Random strobe
248 - 255	Open	
10	<b>Effect macros</b>	
	000 - 007	No action
	008 - 032	Macro 1 : Show 1 without movement
	033 - 057	Macro 2 : Show 2 without movement
	058 - 082	Macro 3 : Show 3 without movement
	083 - 107	Macro 4 : Show 4 without movement
	108 - 132	Macro 5 : Show 5 without movement
	133 - 157	Macro 6 : Show 6 without movement
	158 - 182	Macro 7 : Show 7 without movement
	183 - 207	Macro 8 : Show 8 without movement
208 - 232	Macro 9 : Show 0 without movement	
233 - 255	Full power	
11	<b>Effect macros speed</b>	
	000 - 007	No action
	008 - 247	Increasing speed
248 - 255	Music-sensitive mode	



5.3 - 23-channel mode

Channels	Values	Action
1	<b>PAN 1 movement</b>	
	000 - 255	Projector 1 PAN movements from -45° to 45°
2	<b>PAN 2 movement</b>	
	000 - 255	Projector 2 PAN movements from -45° to 45°
3	<b>PAN 3 movement</b>	
	000 - 255	Projector 3 PAN movements from -45° to 45°
4	<b>PAN 4 movement</b>	
	000 - 255	Projector 4 PAN movements from -45° to 45°
5	<b>TILT movement</b>	
	000 - 255	TILT movement
6	<b>Main dimmer</b>	
	000 - 007	Black-Out
	008 - 255	Dimmer: 0 - 100%
7	<b>Strobe</b>	
	000 - 015	Black-out
	016 - 131	Stroboscope at increasing speed
	132 - 139	Open
	140 - 181	Pulse effect
	182 - 189	Open
	190 - 231	Reversed pulse effect
	232 - 239	Open
	240 - 247	Random stroboscope
248 - 255	Open	
8	<b>Projector 1 dimmer</b>	
	000 - 255	Dimmer: 0 - 100%
9	<b>Projector 2 dimmer</b>	
	000 - 255	Dimmer: 0 - 100%
10	<b>Projector 3 dimmer</b>	
	000 - 255	Dimmer: 0 - 100%
11	<b>Projector 4 dimmer</b>	
	000 - 255	Dimmer: 0 - 100%

5.4 - 15-channel mode

Channels	Values	Action
1	<b>PAN 1 movement</b>	
	000 - 255	Projector 1 PAN movement: 0° - 540°
2	<b>PAN 2 movement</b>	
	000 - 255	Projector 2 PAN movement: 0° - 540°
3	<b>PAN 3 movement</b>	
	000 - 255	Projector 3 PAN movement: 0° - 540°
4	<b>PAN 4 movement</b>	
	000 - 255	Projector 4 PAN movement: 0° - 540°
5	<b>TILT movement</b>	
	000 - 255	TILT movement
6	<b>Movement macros</b>	
	000 - 007	No action
	008 - 034	Macro 1 : Show 1 without light effects
	035 - 061	Macro 2 : Show 2 without light effects
	062 - 088	Macro 3 : Show 3 without light effects
	089 - 115	Macro 4 : Show 4 without light effects
	116 - 142	Macro 5 : Show 5 without light effects
	143 - 169	Macro 6 : Show 6 without light effects
	170 - 196	Macro 7 : Show 7 without light effects
	197 - 223	Macro 8 : Show 8 without light effects
	224 - 255	Macro 9 : Show 0 without light effects

## 5.4 - 15-channel mode (continuation and end)

7	<b>Movement macros speed</b>	
	000 - 007	No action
	008 - 247	Increasing speed
	248 - 255	Music-sensitive mode
8	<b>Main dimmer</b>	
	000 - 007	Black-Out
	008 - 255	Dimmer: 0 - 100%
9	<b>Strobe</b>	
	000 - 015	Black-out
	016 - 131	Stroboscope at increasing speed
	132 - 139	Open
	140 - 181	Pulse effect
	182 - 189	Open
	190 - 231	Reversed pulse effect
	232 - 239	Open
	240 - 247	Random stroboscope
	248 - 255	Open
10	<b>Projector 1 dimmer</b>	
	000 - 255	Dimmer: 0 - 100%
11	<b>Projector 2 dimmer</b>	
	000 - 255	Dimmer: 0 - 100%
12	<b>Projector 3 dimmer</b>	
	000 - 255	Dimmer: 0 - 100%
13	<b>Projector 4 dimmer</b>	
	000 - 255	Dimmer: 0 - 100%
14	<b>Effect macros</b>	
	000 - 007	No action
	008 - 032	Macro 1 : Show 1 without movement
	033 - 057	Macro 2 : Show 2 without movement
	058 - 082	Macro 3 : Show 3 without movement
	083 - 107	Macro 4 : Show 4 without movement
	108 - 132	Macro 5 : Show 5 without movement
	133 - 157	Macro 6 : Show 6 without movement
	158 - 182	Macro 7 : Show 7 without movement
	183 - 207	Macro 8 : Show 8 without movement
	208 - 232	Macro 9 : Show 0 without movement
	233 - 255	Full power
15	<b>Effect macros speed</b>	
	000 - 007	No action
	008 - 247	Increasing speed
	248 - 255	Music-sensitive mode

## 6 - DMX cabling and addressing for each mode

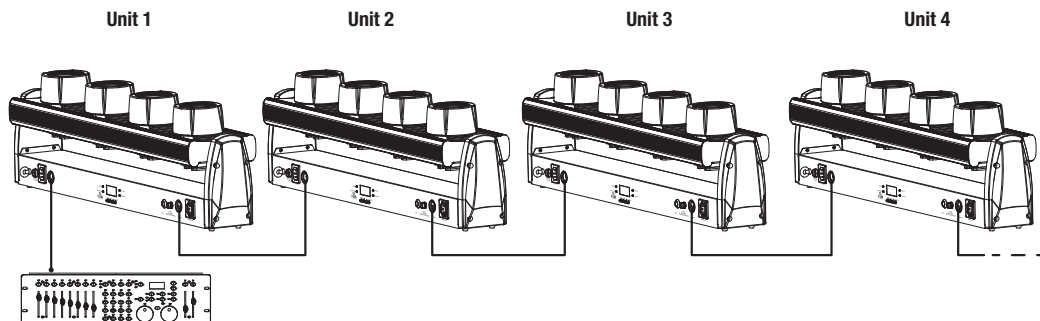

DMX mode	Unit 1 address	Unit 2 address	Unit 3 address	Unit 4 address
1 channel	1	2	3	4
11 channels	1	12	23	34
15 channels	1	16	32	48

## 7 - How to use the EASY-2 remote control (optional)

The EASY-2 remote control is straightforward and easy to install. It is able to control several synchronised units with the Master/Slave mode.

Plug your remote control into the Master projector Jack 6.35 chassis called «ONLY FOR REMOTE CONTROL», and daisy chain the additional units via the XLR plugs, as you would for a regular DMX cabling. This remote control gives you access to the following functions: black-out, strobe, and show selection.

Button	Action	
STAND - BY	Black-out	
FUNCTION	For each push : 1 : Music-sensitive strobe 2 : Automatic strobe	Show selection: 0 - 8
MODE	Random show (LED OFF)	Show (LED ON)

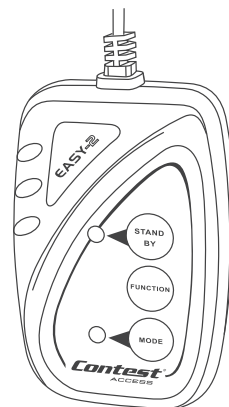

Because CONTEST® takes the utmost care in its products to make sure you only get the best possible quality, our products are subjects to modifications without prior notice. That is why technical specifications and the products physical configuration might differ from the illustrations.

Make sure you get the latest news and updates about the CONTEST® products on [www.contest-lighting.com](http://www.contest-lighting.com)  
CONTEST® is a trademark of HITMUSIC S.A. - Zone Cahors sud - 46230 FONTANES - FRANCE